



Brasem in de Blocq van Kuffeler

Highway to heaven?

Inhoud

- Locatie: Almere
- Probleem: dode vissen
- Oorzaak: vissen in persbuis
- Oplossingsrichtingen
- 2023 als leerjaar
- Wat volgt?

Gemaal de Blocq van Kuffeler, Almere

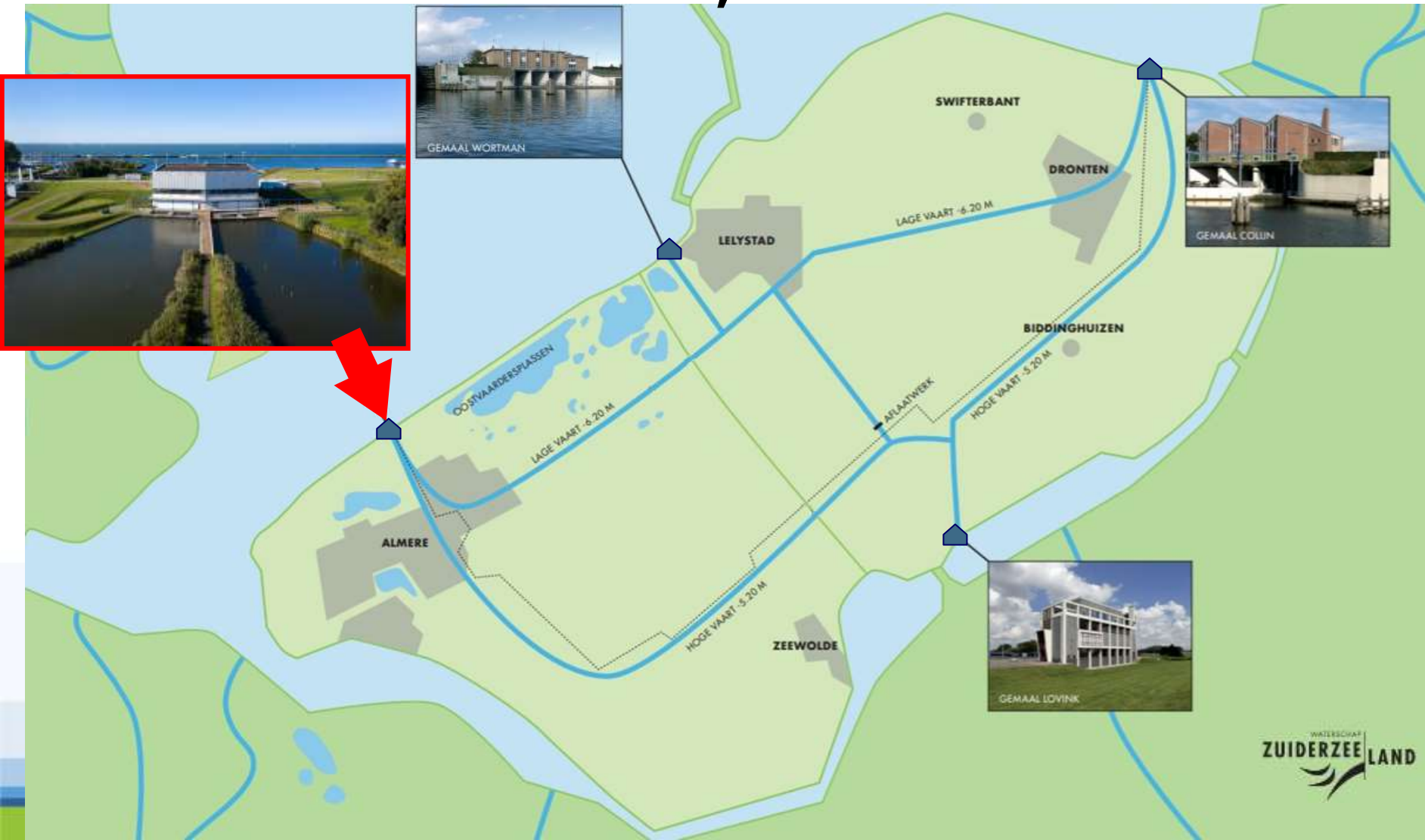

Probleem- dode vissen

- Sinds 2017 meldingen vissterfte
- 2019 – Omroep Flevoland

“Natuurlijk fenomeen”



Toch niet zo natuurlijk..

- 2022: Vis in persbuis?!

Persbuis

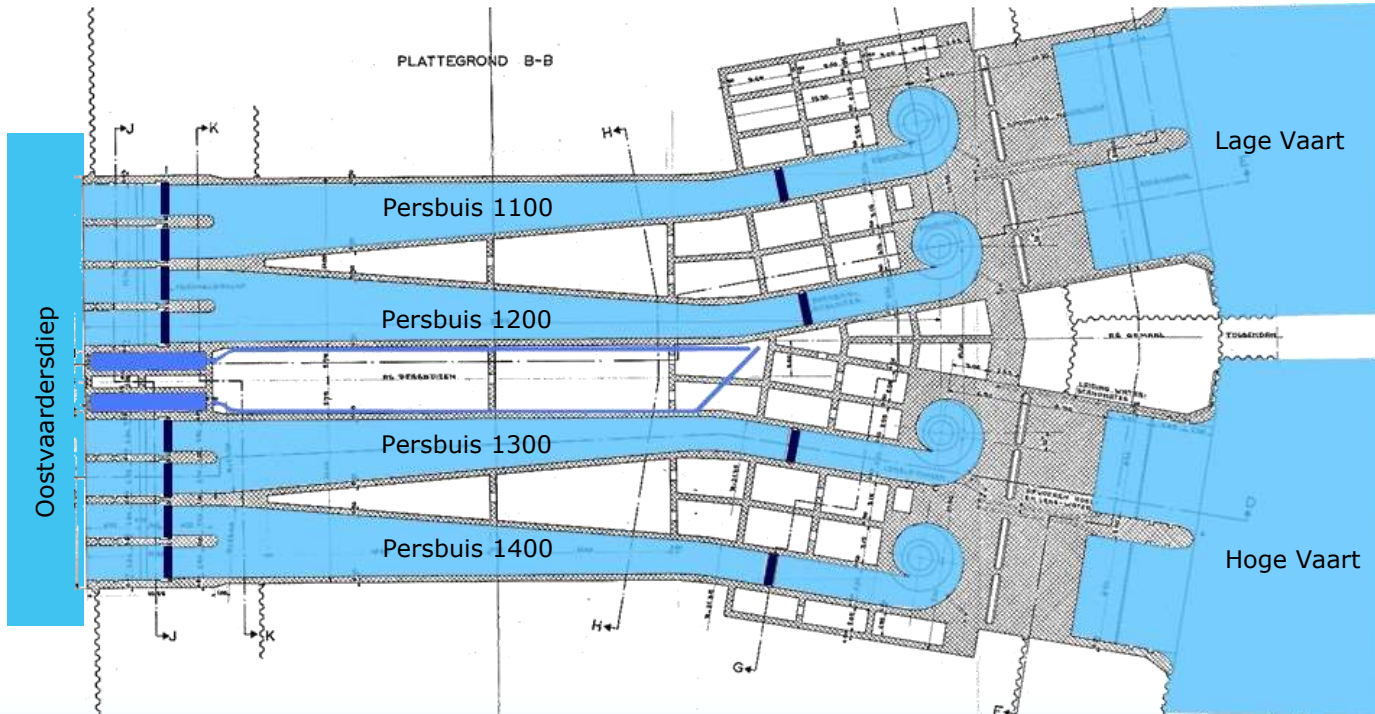



Oorzaak – vissen in persbuis

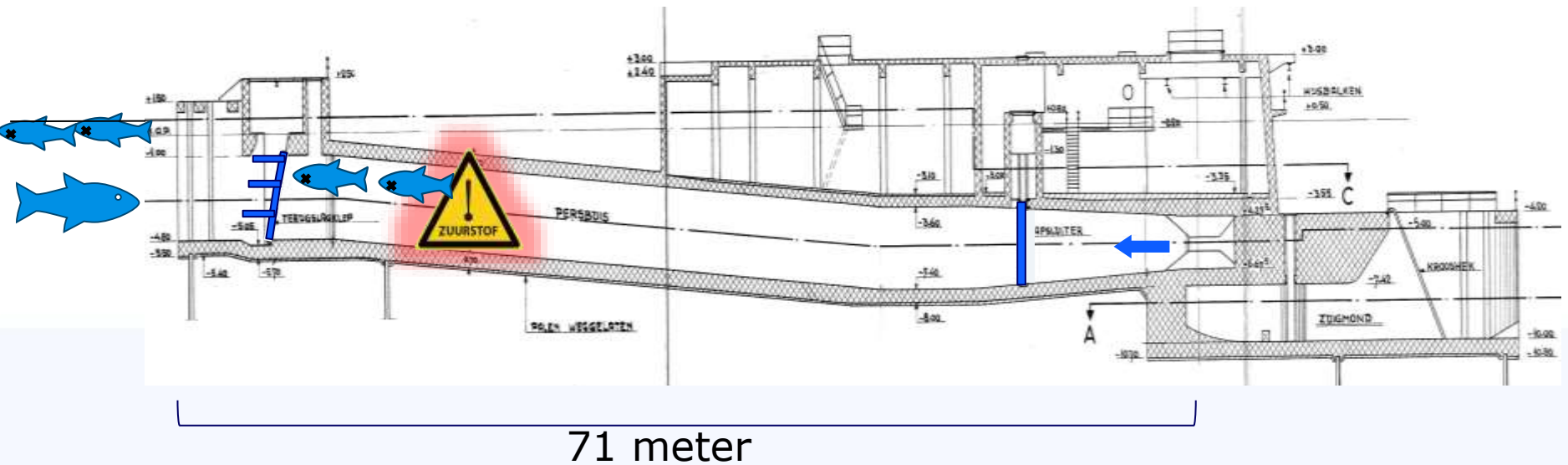



Oplossingsrichtingen

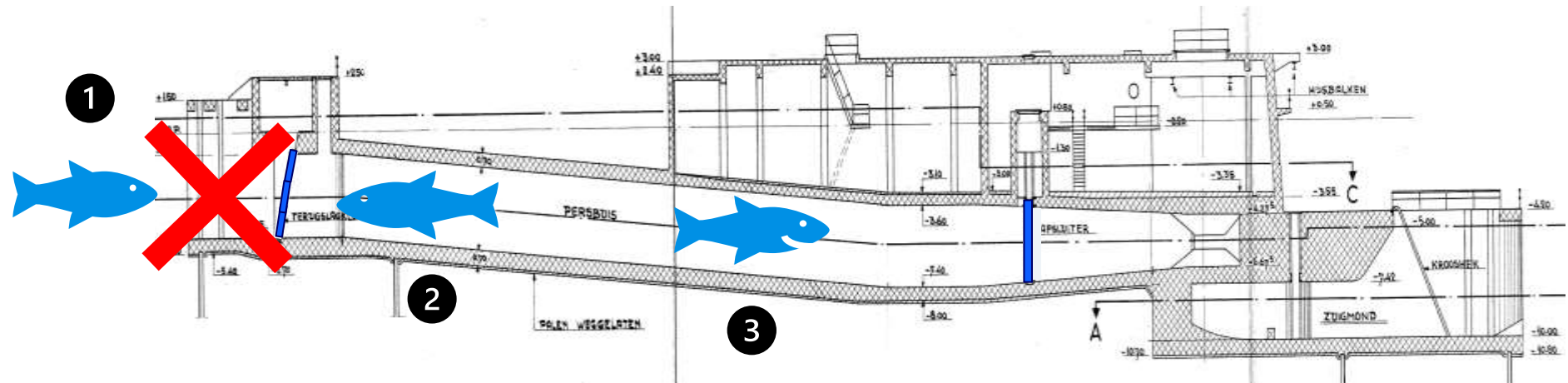

2023

Lage Vaart

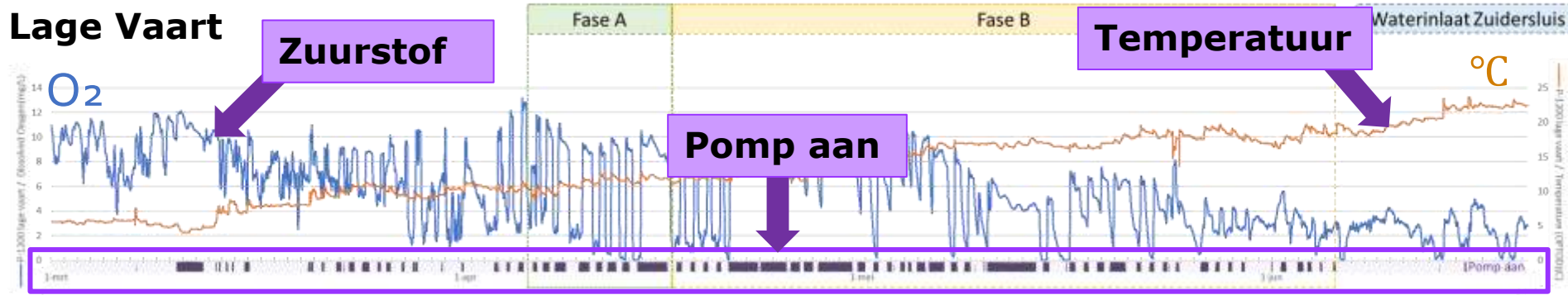

Hoge Vaart

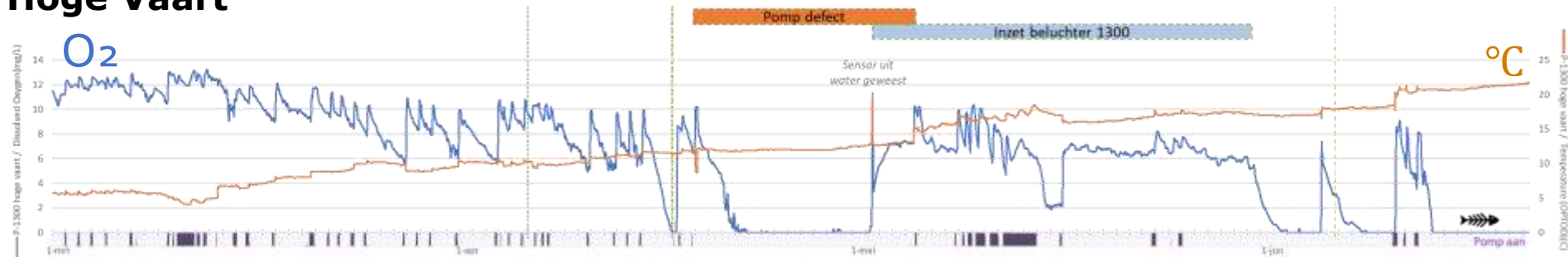

2023

6 april: de brasem voor het gemaal neemt toe
→ **Fase A**



Lage Vaart

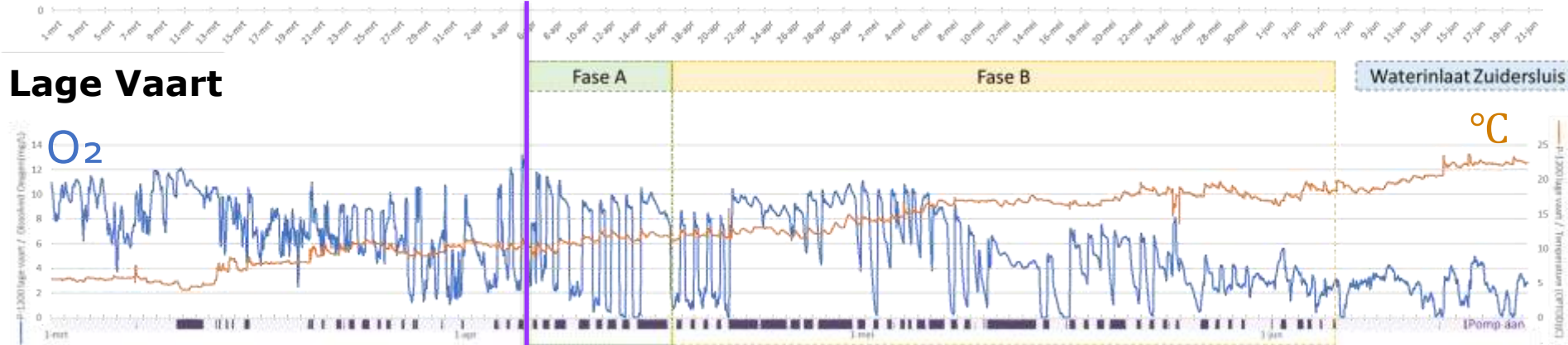

Hoge Vaart

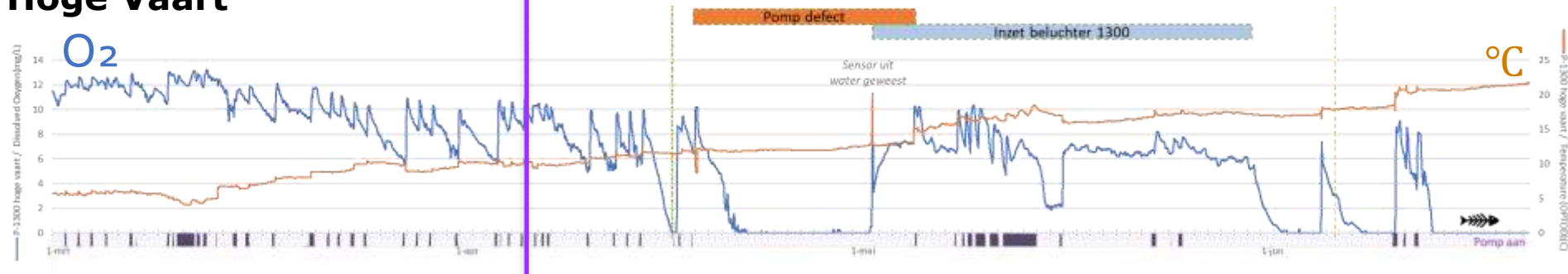

2023

Maar.. Maart was nat,
dus pomp toch nodig

Lage Vaart

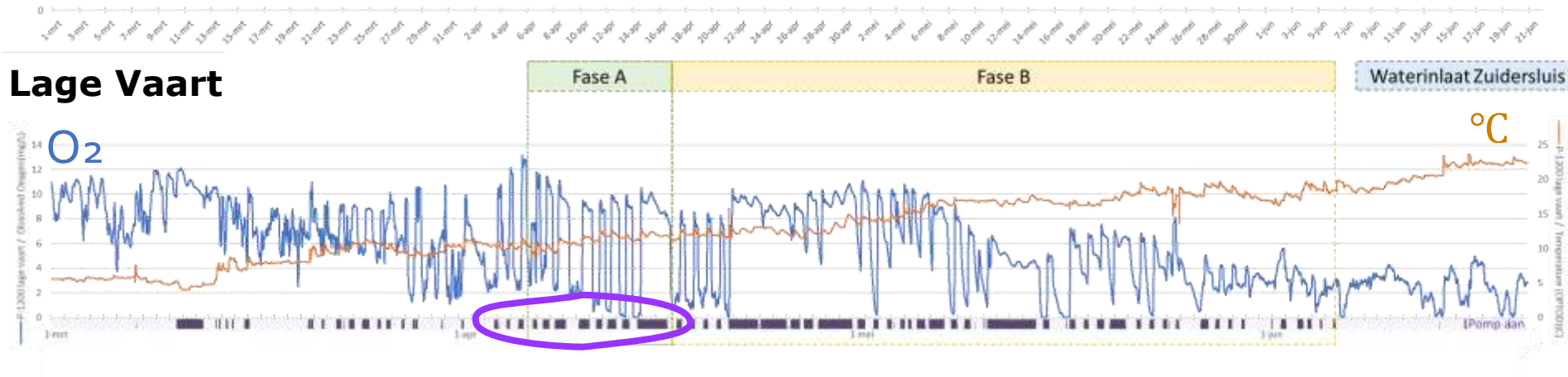

Hoge Vaart

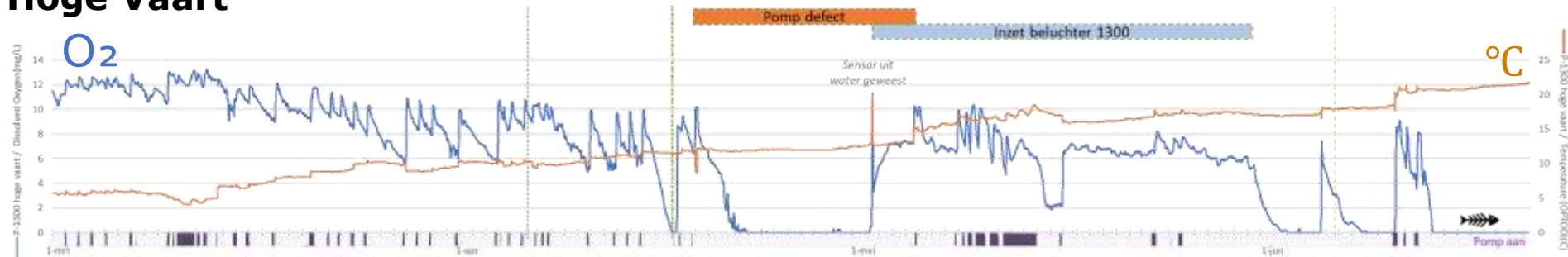

2023

17 april:
happende vis
→ **Fase B**



Lage Vaart



Hoge Vaart

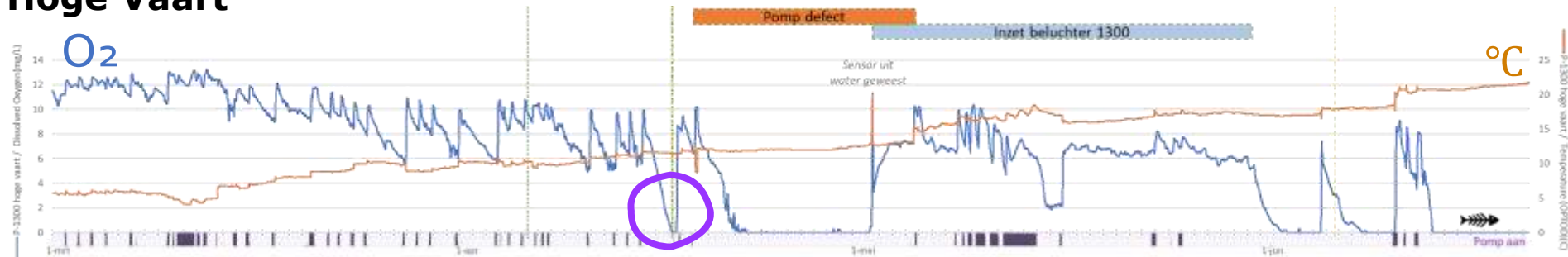

2023



18 april:

- Pomp defect Hoge Vaart
- Zuurstof zakt uit
- Maar.. geen vis te zien

Lage Vaart



Hoge Vaart

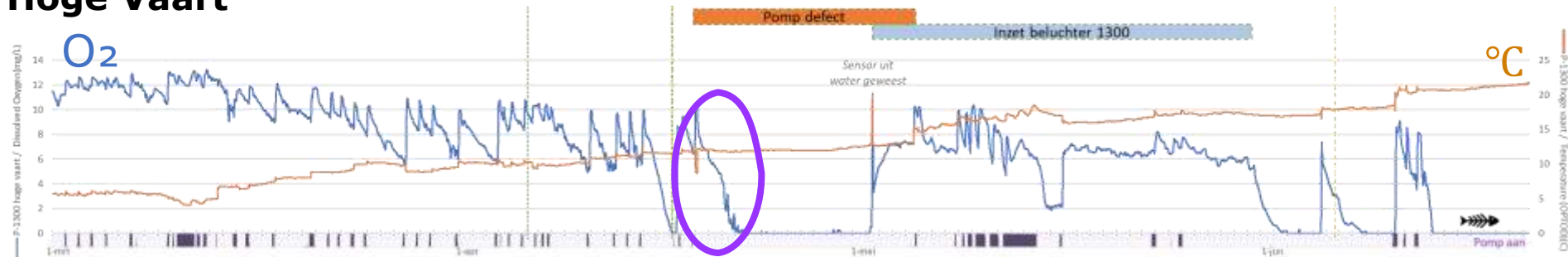

2023

1 mei:

- Happende vissen na 13d

2 mei: beluchter, O₂ ↑



2023

5 mei:
Pomp weer operationeel



Lage Vaart



Hoge Vaart

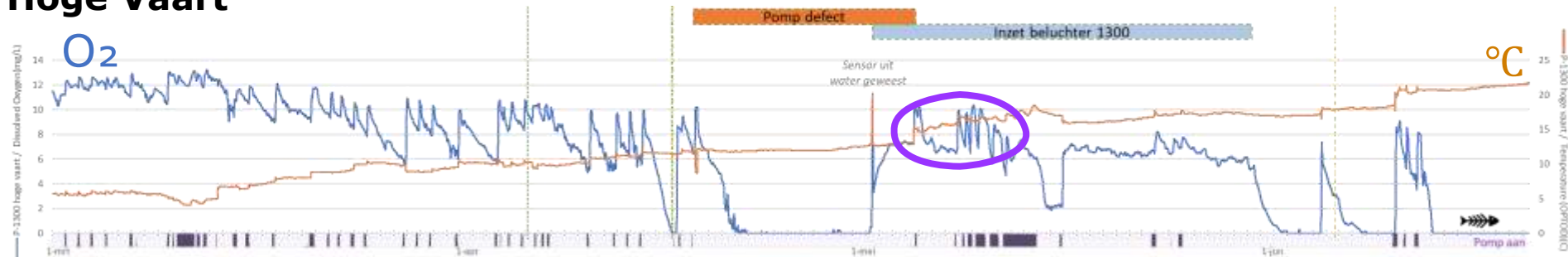

2023

31 mei: beluchter verplaatst



Lage Vaart



Hoge Vaart

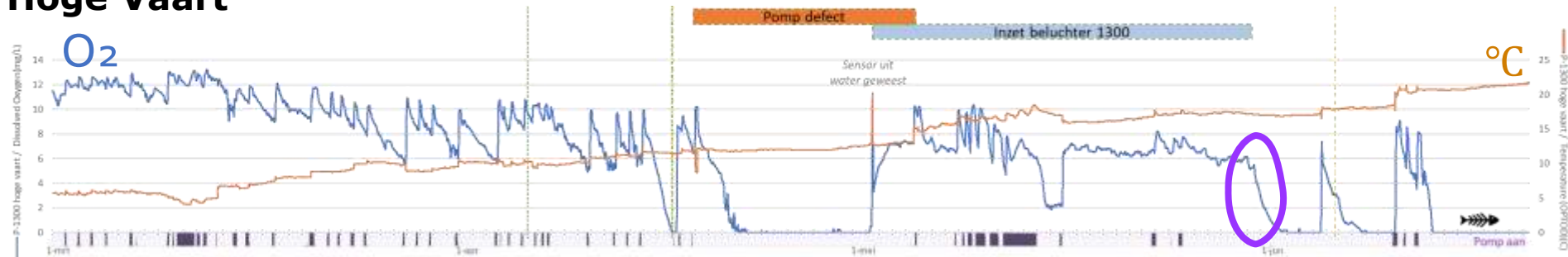

2023

19 juni:
Dode vissen
in persbuis

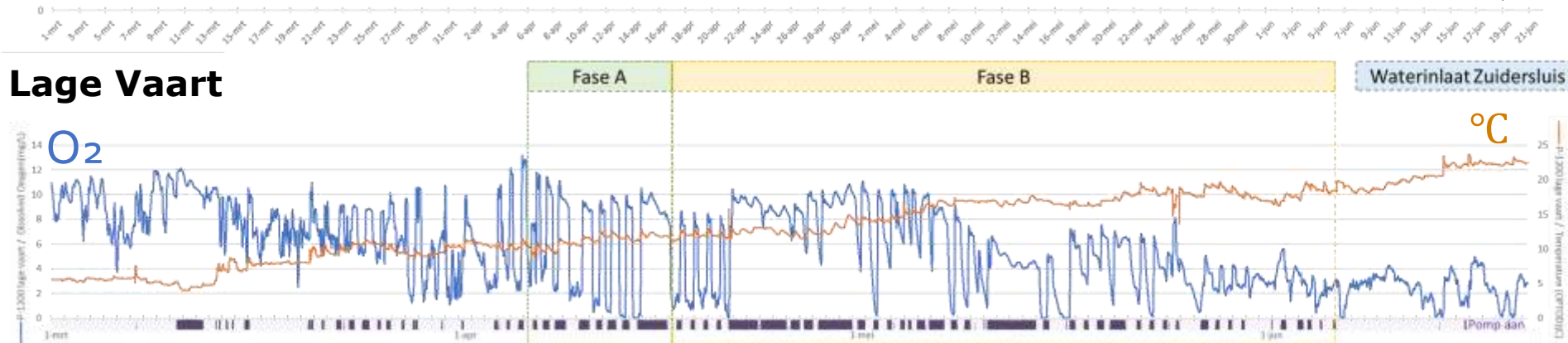

Hoge Vaart



Sonar - visgedrag



Maatregelen 2024

- April + mei: aanpassen bemaling



- Pompen zo lang mogelijk uit



- Als toch nat: pompen juist vaker aan

- Beluchters



- Aanschaf eigen sonar?

Wat volgt?

- Verkenning vispassage
- Uitzwem maatregel?

